

SecuriFire

SecuriFire Planning Manual

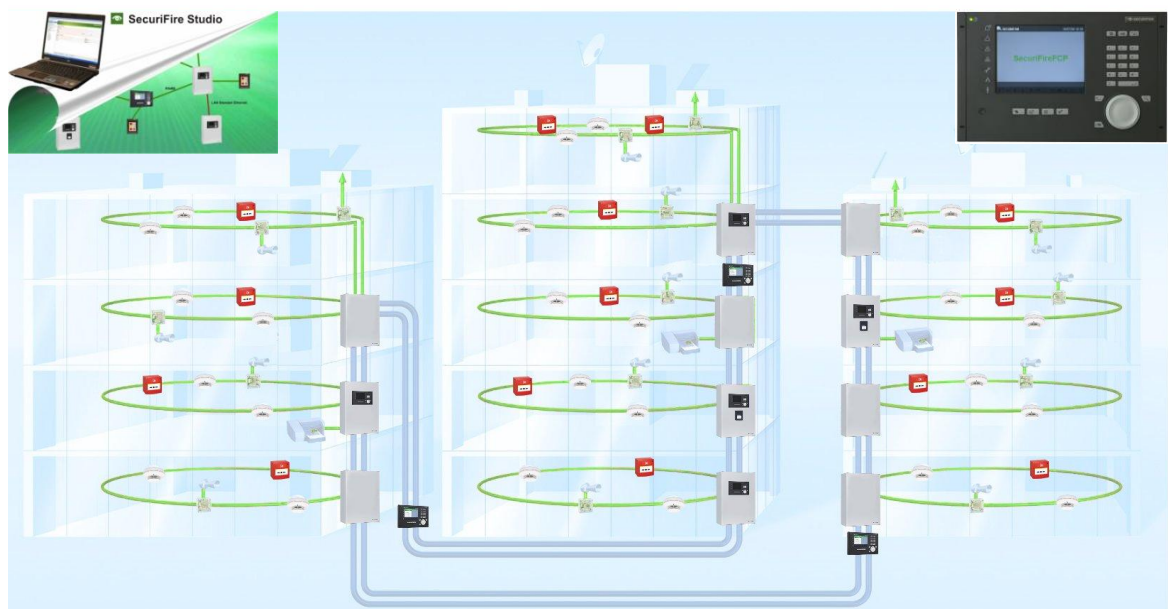

Contents

1	Introduction	5
1.1	General information about planning SecuriFire fire alarm systems	5
1.2	Standards and approvals	5
1.3	Basic aspects of planning	5
2	SecuriFire system family	6
2.1	Overview	6
2.2	SecuriFire system limits	6
2.3	SecuriFire areas of application	7
2.4	Example of a SecuriFire system layout	7
3	Overview of control panels of the SecuriFire system family	8
3.1	Modular control panel, SCP3000 series	9
3.2	Compact control panel, SCP2000 series	12
3.3	Compact control panel, SCP1000 series	14
3.4	Compact control panel SCP500	14
4	Indication and control maps	15
5	SecuriLine eXtended	17
5.1	Manual fire detectors	17
5.2	Automatic fire detectors	18
5.3	Base for automatic fire detectors	21
5.4	Room indication lamps	21
5.5	Sirens and flashlights	22
5.6	SecuriLine eXtended line modules	24
5.7	Wireless	25
5.8	Ex-zone detector	26
5.9	Special fire detectors	27
6	Article Numbers	27
7	System planning	28
7.1	Detection area	28
7.2	Detection zone	29
7.3	Avoidance of false alarms	30
7.4	Positioning of automatic fire detectors	31
7.5	Choice of fire detector types based on ambient conditions	32
7.6	Room heights	33
7.7	Monitoring areas for point detectors	33
7.8	Distance between detector and ceiling or roof	34
7.9	In narrow corridors and ceiling areas	35
7.10	Distances from walls	35
7.11	Distance from stored goods and storage facilities	35
7.12	Positioning of manual fire detectors MCP	36

1 Introduction



Notice

This document applies to SRP version 2.1 (SecuriFire release package).

1.1 General information about planning SecuriFire fire alarm systems

This document consists first and foremost of the components that make up the SecuriFire family of systems, together with their main properties for planning a norm-compliant fire alarm system.

The planning work may be based on the relevant sets of standards as well as national and regional regulations and directives.

This document focuses on the planning of new systems, from compact panels to large-scale fire alarm systems.

1.2 Standards and approvals

The SecuriFire fire alarm system complete with peripherals complies with the relevant European EN54 norms. It also satisfies the requirements of VdS in Germany and VKF (Cantonal Fire Insurance Union) in Switzerland.

Securiton continuously updates and documents the current status of its accreditations and approvals.

1.3 Basic aspects of planning

As the SecuriFire fire alarm system is modular in design, all types of system configuration are conceivable. Both centralised and decentralised systems (or combinations thereof) can be implemented, depending on needs and requirements. A number of factors influence the system configuration:

- Legislation, regulations and guidelines
- Customer requirements
- Structural factors relating to the building
- New system, replacement of an existing system, extension
- Cost-benefit ratio

2 SecuriFire system family

2.1 Overview

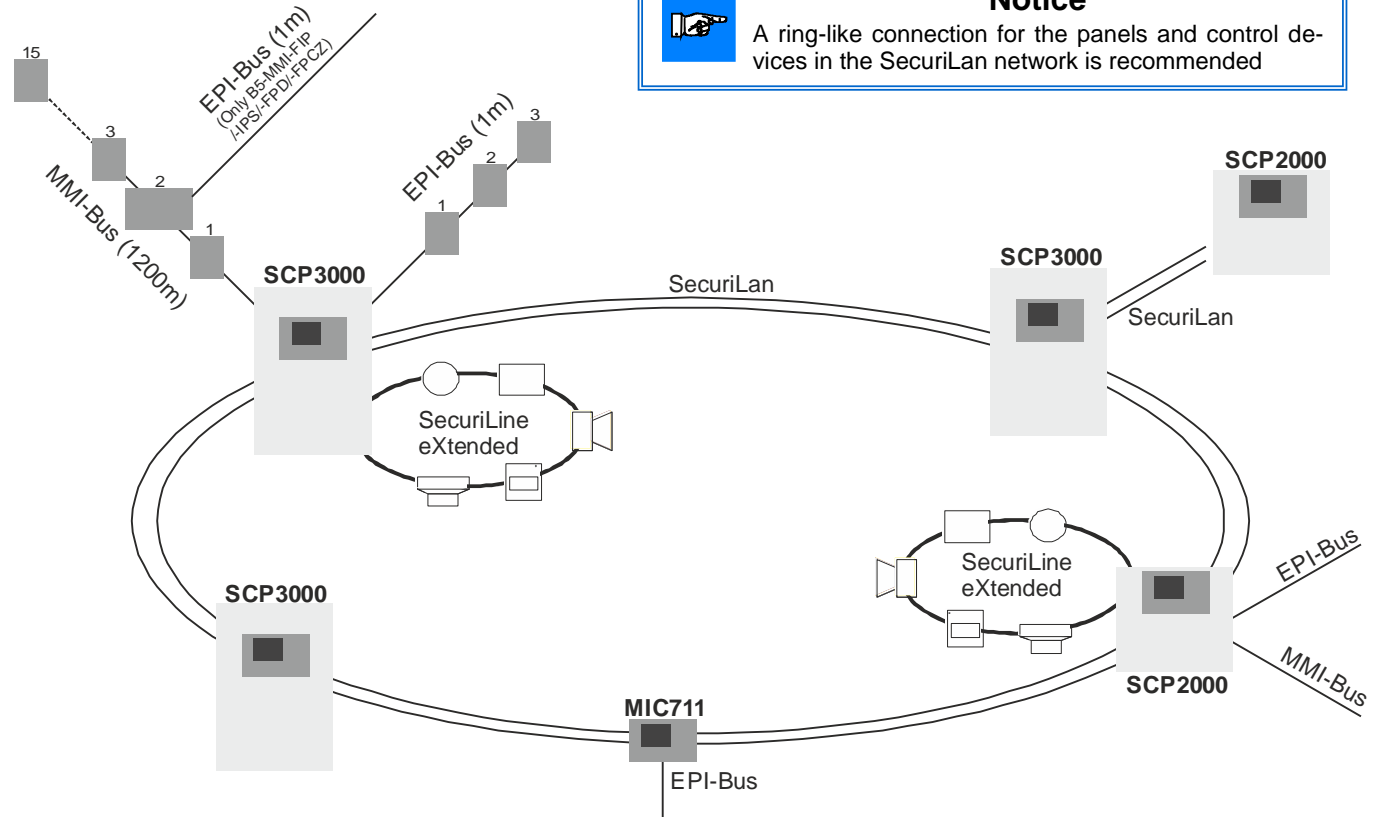

- | | | |
|--------------------------|------------------------|------------------------|
| SecuriLan devices | MMI-Bus devices | EPI-Bus devices |
| SCP2000 | B5-MMI-FIP | B5-EPI-FPC |
| SCP3000 | B5-MMI-FPD | B5-EPI-ASP |
| B5-MIC711 | B5-MMI-FPCZ | B5-EPI-PCM |
| B6-MIC711 | B3-MMI-EAT32 | B5-EPI-PIM |
| | B3-MMI-EAT64 | B5-EPI-FPD |
| | B3-MMI-IPEL | B5-EPI-FAT |
| | B3-MMI-IPES | B5-EPI-FPS |
| | B3-MMI-FAT | B5-EPI-FPCZ |
| | B3-MMI-FPS | |
| | B5-MMI-FPS | |
| | B3-MMI-IPS | |
| | B5-MMI-IPS | |
| | B3-MMI-UIO | |

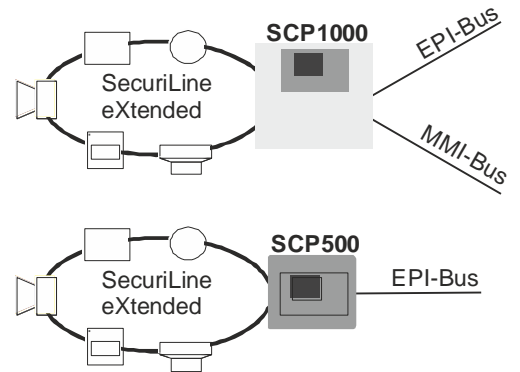

2.2 SecuriFire system limits

	SCP500	SCP1000	SCP2000	SCP3000	SecuriLan
Element					
SCP 2000/3000 control panels	---	---	---	---	16
MIC711 ext. indication and control maps	---	---	---	---	31
Σ SCP+MIC711	---	---	---	---	32
MIC11 int. indication and control maps	1	1	1	1	16
Printers (external, internal)	---	3	3	3	16x3
EPI- basic interfaces	1	1 per MIC 1 per B5-MMI-FIP/IPS/FPD/FPCZ			Additionally 1 per MIC711
EPI-Devices	3 devices per EPI - basic interface				
MMI- basic interfaces	0	1	1	1 pro BAF	
MMI-Devices	max. 15 devices per MMI master interface additional condition: $(B5-MMI^1) + 2*(B3-MMI^2) + 3*(EPI^3) \leq 16$				

Detection zones	total	total	total	total	4096
Inputs	768	768	768	768	4096
Outputs					4096

2.3 SecuriFire areas of application

Typical application	Suitable product
Up to 250 detectors, max. 1 loop, stand-alone	SCP500 / SCP1000
Up to 1000 detectors, max. 4 loops, stand-alone	SCP2000
Up to 500 detectors, max. 2 loops, networked	
Up to 500 detectors, max. 2 loops, stand-alone, with 1 extinguishing area	SCP3000
Up to 3500 detectors, max. 14 loops, networked or stand-alone, up to 8 extinguishing areas	MIC711
Remote main indication and control map	

2.4 Example of a SecuriFire system layout

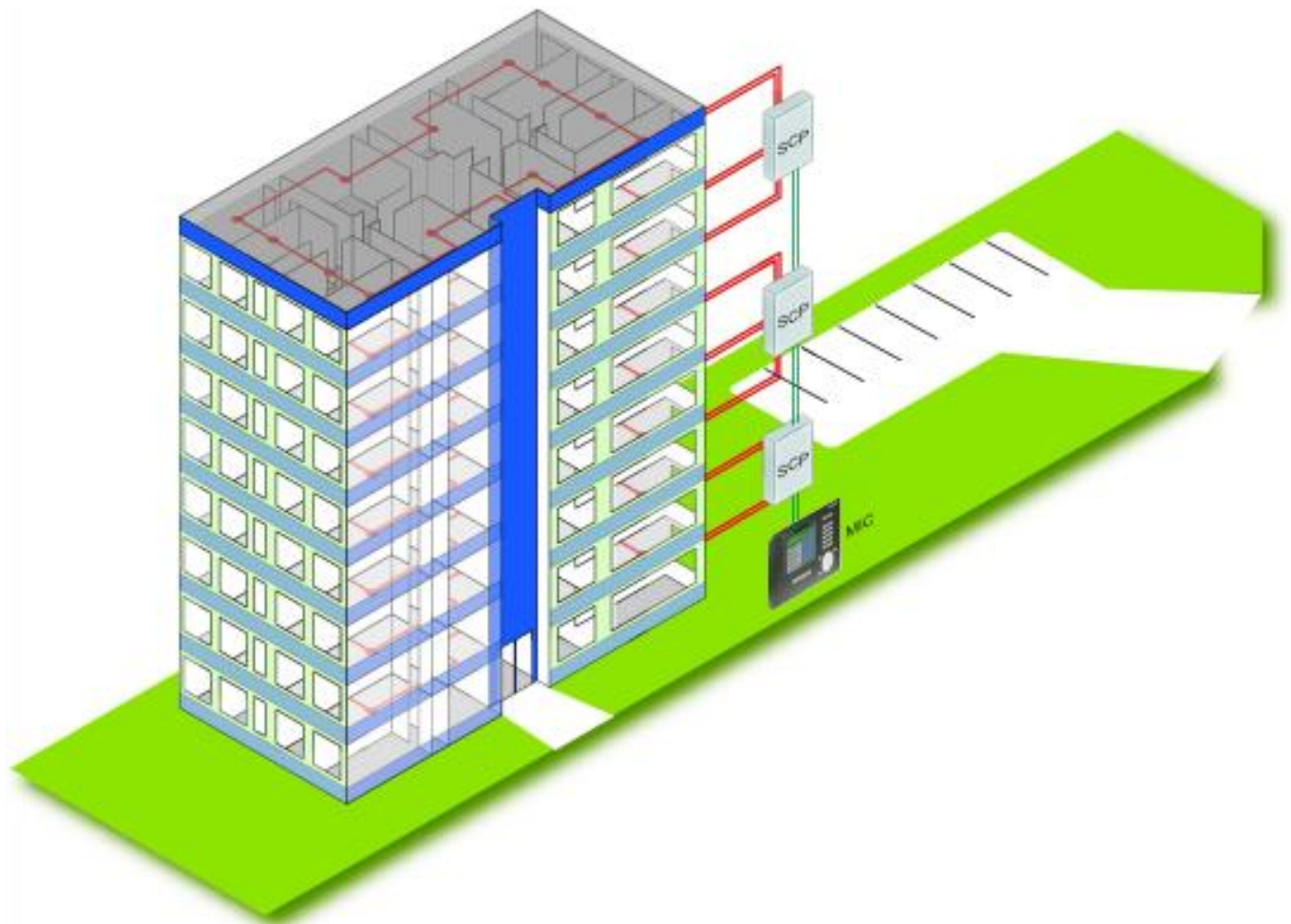

3 Overview of control panels of the SecuriFire system family



Compact control panel
SecuriFire 500

Stand-alone fire alarm control panel with 1 addressable loop for max. 250 addresses

Dimensions: 300 x 360 x 100 mm



Compact control panels
SecuriFire 1000 and
SecuriFire 2000

SecuriFire 1000
Stand-alone fire alarm control panel with 1 addressable loop for max. 250 addresses

Dimensions: 400 x 445 x 150 mm

SecuriFire 2000
Fire alarm control panel with up to 4 addressable loops for max. 250 addresses each. Networked with other control panels via SecuriLan.
Variant with 1 zone extinguishing system.



Modular control panels
SecuriFire 3000

Fire alarm control panel with up to 16 addressable loops for max. 250 addresses each.

Dimensions: 600 x 445 x 225 mm

Networked with other control panels via SecuriLan.
Variant with 8 zone extinguishing systems.
The modular design allows for an adaptable, requirements-based functional scope using the appropriate boards.

3.1 Modular control panel, SCP3000 series

Basic design of the SCP3000

The basic design of a control panel comprises the map case, the space for the batteries (2x45 Ah), the rack with the control unit (B5-MCB15) and the power supply unit (B5-PSU). Variants are available with/without integrated MIC control panel and integrated printer.

SCP3000 rack

	MCB15	Free slot	Free slot	Free slot	Free slot	Free slot	Free slot	Free slot	Free slot	Free slot	PSU	Free slot	Free slot	Free slot
	1	2	3	4	5	6	7	8	9	10	11	12	13	

The unit rack of each SCP3000 has 8 + 3 free slots for accommodating plug-in boards. The plug-in boards are selected and fitted in accordance with the requirements of the FACP.

Optional plug-in boards for the SCP3000

Plug-in boards for slots 2-9		
<p>B5-BAF Basic functions</p> <p>Slot: 9</p>	<p>Application</p> <ul style="list-style-type: none"> • MMI interface for connecting up to 15 other MMI devices • Interface for connecting a parallel FBF according to DIN 14661 and a parallel FBA according to SN 054002 • 2 outputs monitored • 2 inputs monitored <p>Remarks</p> <ul style="list-style-type: none"> • The B5-BAF must be fitted to slot 9 if plug-in boards are used in slots 11-13. 	
<p>B5-DXI2 2 alarm loops</p> <p>Slot: 2-8</p>	<p>Application</p> <ul style="list-style-type: none"> • Interfaces for connecting 2 fire detection lines in SecuriLine eXtended loop topology. • Up to 250 addresses per line 	
<p>B3-IM8 8 detection zones</p> <p>Slot: 2-8</p>	<p>Application</p> <ul style="list-style-type: none"> • Connection of a total of 8 detection zones or monitored inputs • Hand switch and detector series SecuriStar 563 	

Overview of control panels of the SecuriFire system family

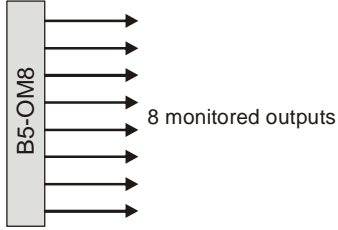
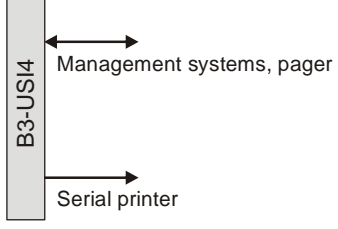
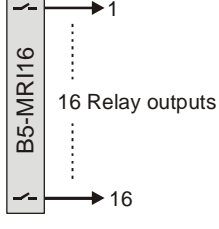
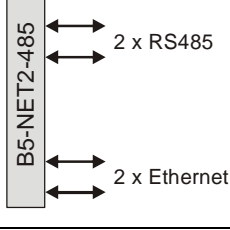
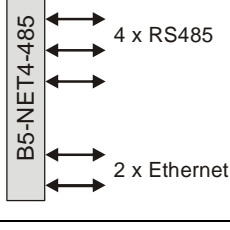
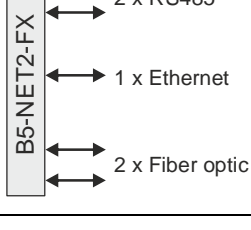
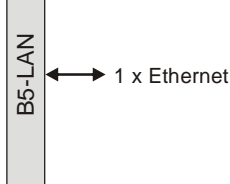
<p>B5-OM8 8 monitored outputs</p> <p>Slot: 2-8</p>	<p>Application</p> <ul style="list-style-type: none"> • Connection of peripherals such as sirens, flashlights, etc. • max. 1.5A per output 	 <p>B5-OM8</p> <p>8 monitored outputs</p>
<p>B3-USI4 2 communication interfaces</p> <p>Slot: 2-8</p>	<p>Application</p> <ul style="list-style-type: none"> • Connection of management systems, pagers (ESPA 4.4.4), RMS email servers or RMS text message servers • Connection of serial printers 	 <p>B3-USI4</p> <p>Management systems, pager</p> <p>Serial printer</p>
<p>B5-MR16 16 relays</p> <p>Slot: 2-9</p>	<p>Application</p> <ul style="list-style-type: none"> • Actuation of consumer units • Load 24V/3A, NC or NO contacts • Programmable as required 	 <p>B5-MR16</p> <p>16 Relay outputs</p>
<p>B5-NET2 485 Network interfaces</p> <p>Slot: 2</p>	<p>Application</p> <ul style="list-style-type: none"> • Norm-compliant networking in SecuriLan, via 2 RS485 interfaces. • 2 TX Base 100 interfaces for IP connection, e.g. PC. 	 <p>B5-NET2-485</p> <p>2 x RS485</p> <p>2 x Ethernet</p>
<p>B5-NET4 485 Network interfaces</p> <p>Slot: 2</p>	<p>Application</p> <ul style="list-style-type: none"> • Norm-compliant networking in SecuriLan, via 4 RS485 interfaces. • 2 Ethernet interfaces for IP connection, e.g. PC. 	 <p>B5-NET4-485</p> <p>4 x RS485</p> <p>2 x Ethernet</p>
<p>B5-NET2 FX(S/M) Network interfaces</p> <p>Slot: 2</p>	<p>Application</p> <ul style="list-style-type: none"> • Norm-compliant networking in SecuriLan, via 2 RS485 interfaces or via fibre optic cable.. • B5-NET2-FXM: Multi-mode cable, up to 2000m • B5-NET2-FXS: Single-mode cable, up to 10000m 	 <p>B5-NET2-FX</p> <p>2 x RS485</p> <p>1 x Ethernet</p> <p>2 x Fiber optic</p>
<p>B5-LAN Network interfaces</p> <p>Slot: 2</p>	<p>Application</p> <ul style="list-style-type: none"> • Non-redundant networking in SecuriLan, via Ethernet interface. • Non-redundant networking of PC applications, via Ethernet interface. 	 <p>B5-LAN</p> <p>1 x Ethernet</p>

Overview of control panels of the SecuriFire system family

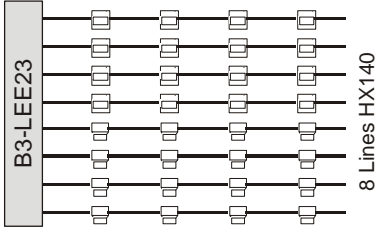
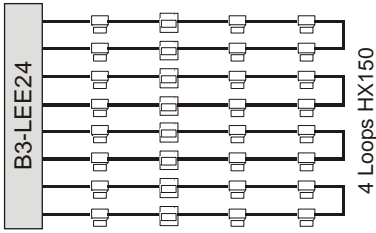
<p>B3-LEE23 8 alarm lines HX 140</p> <p>Slot: 2-8</p>	<p>Application</p> <ul style="list-style-type: none"> • Connection of HX 150 series detectors. • 8 stub lines with up to a maximum of 30 detectors each 	 <p style="text-align: right;">8 Lines HX140</p>
<p>B3-LEE24 8 alarm lines HX 140</p> <p>Slot: 2-8</p>	<p>Application</p> <ul style="list-style-type: none"> • Connection of HX 150 series detectors. • 4 addressable loops with up to a maximum of 127 detectors each 	 <p style="text-align: right;">4 Loops HX150</p>

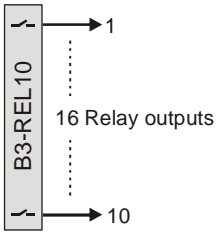
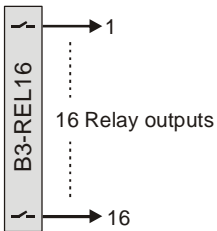
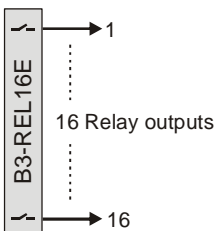
Plug-in boards for slots 11-13		
<p>B3-REL10 10 relays</p> <p>Slot: 11-13</p>	<p>Application</p> <ul style="list-style-type: none"> • Actuation of consumer units • Load 230V/3A, NC or NO contacts • Programmable as required 	 <p style="text-align: center;">16 Relay outputs</p>
<p>B3-REL16 16 relays</p> <p>Slot: 11-13</p>	<p>Application</p> <ul style="list-style-type: none"> • Actuation of consumer units • Load 24V/3A, NC or NO contacts • Programmable as required 	 <p style="text-align: center;">16 Relay outputs</p>
<p>B3-REL16E 16 relays</p> <p>Slot: 11-13</p>	<p>Application</p> <ul style="list-style-type: none"> • Actuation of consumer units • Load 24V/3A, NC or NO contacts • Contacts individually protected by 3A fuse • Programmable as required 	 <p style="text-align: center;">16 Relay outputs</p>

Overview of control panels of the SecuriFire system family

3.2 Compact control panel, SCP2000 series

Basic design of the SCP2000

Even in its basic design the SCP2000 is a fully fledged fire alarm control panel.

The basic design of a control panel comprises: the map case, the space for the batteries (2x17 Ah), the power supply unit (B6-PSU), the control unit (B6-MCB13) with free slot for an additional unit. Variants are available with/without integrated MIC control panel and integrated printer.

Key features of the SCP2000 basic design include:

- 2 addressable loops for a maximum of 250 addresses each
- MMI interface for connecting up to 15 other MMI devices
- Interface for fire brigade panels and monitored outputs for alarm transmission.
- An additional network unit is required for networking within the SecuriLan (not included in the basic design)

The optional unit (max. 1) is selected and fitted in accordance with the requirements of the FACP.

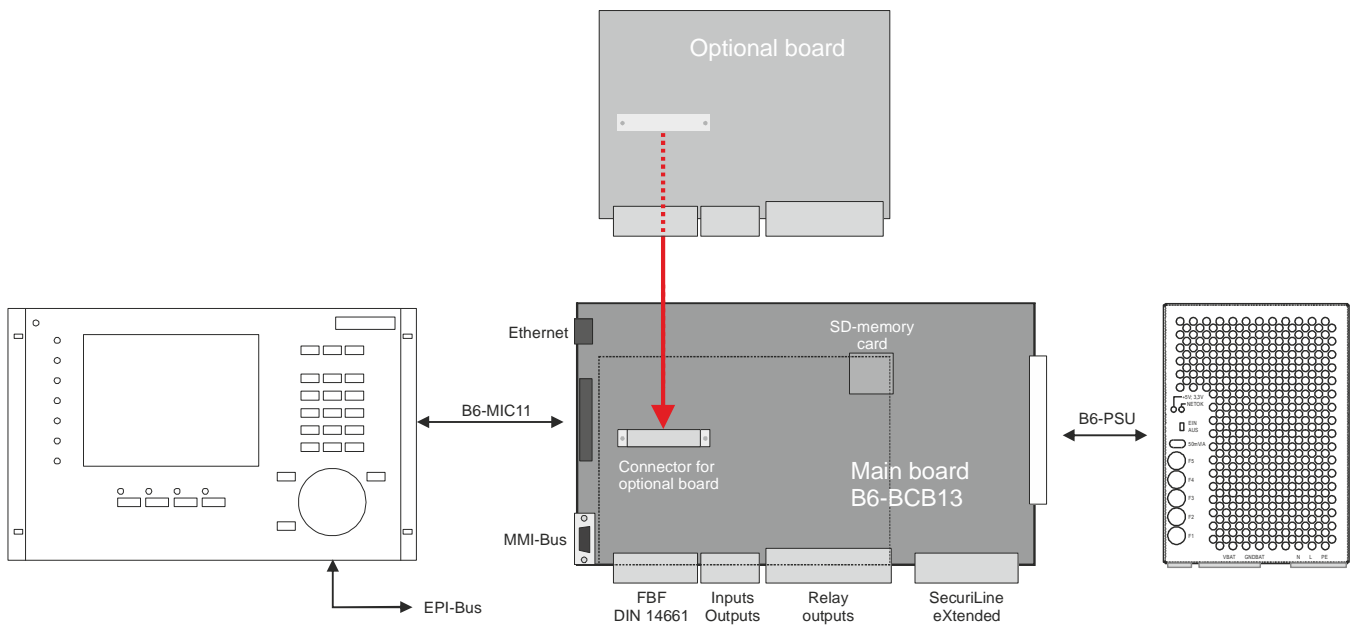

Overview of control panels of the SecuriFire system family

SCP2000 optional units

Units for optional slot		
B6-DXI2 2 alarm loops	Application <ul style="list-style-type: none"> • Interfaces for connecting an additional 2 fire detection lines in SecuriLine eXtended loop topology. • Up to 250 addresses per line 	
B6-LXI2 2 alarm loops 2 LAN ports for third-party systems	Application <ul style="list-style-type: none"> • Interfaces for connecting an additional 2 fire detection lines in SecuriLine eXtended loop topology. • Up to 250 addresses per line • 2 LAN ports for connecting third-party systems, RMS servers and RME servers. 	
B6-LAN 1 LAN interface	Application <ul style="list-style-type: none"> • Interfaces for connecting PC applications • Connection of other participants (SCP3000, SCP2000, MIC711) of the SecuriLan. Caution: not norm-compliant! 	
B6-NET2-485 Network unit, cop- per cable	Application Connection of other participants (SCP3000, SCP2000, MIC711) of the SecuriLan. Connection via copper cable up to 1200m	
B6-NET2-FX(S/M) Network unit Fibre optic cable	Application <ul style="list-style-type: none"> • Connection of other participants (SCP3000, SCP2000, MIC711) of the SecuriLan. Connection via fibre optic cable. • B6-NET2-FXM: Multi-mode cable, up to 2000m • B6-NET2-FXS: Single-mode cable, up to 10000m 	
B4-USI Interfaces for third- party systems	Application <ul style="list-style-type: none"> • 2 serial interfaces for connecting external systems such as management systems, pagers (ESPA 4.4.4), external printer, text message server, email server, etc. 	
B6-EIO 10 inputs and 8 outputs	Application <ul style="list-style-type: none"> • Connection of up to 10 collective alarm lines • Use as 1 area extinguishing • Freely programmable inputs and outputs for any application 	

Overview of control panels of the SecuriFire system family

3.3 Compact control panel, SCP1000 series

The SCP1000 is a fully fledged fire alarm control panel complete with integrated control panel. Variants are available with/without integrated printer.

Key features of the SCP1000 include:

- 1 addressable loop for a maximum of 250 addresses
- MMI interface for connecting up to 15 other MMI devices
- Interface for fire brigade panels and monitored outputs for alarm transmission
- The SCP1000 is an autonomous stand-alone control panel and cannot be networked

This type of control panel does not provide any options for fitting additional units.

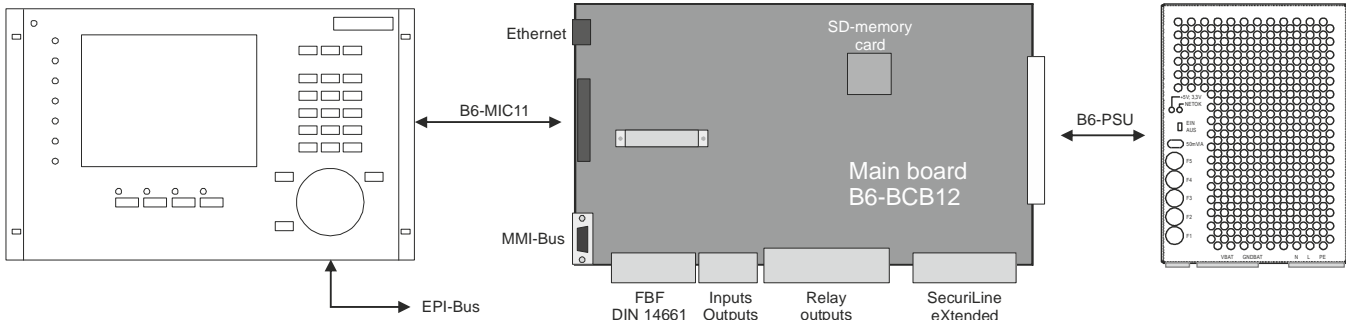

3.4 Compact control panel SCP500

The SCP500 is a fully fledged fire alarm control panel complete with integrated control panel, but without integrated printer.

Key features of the SCP500 include:

- 1 addressable loop for a maximum of 250 addresses
- EPI interface for 3 indication and control panels (incl. fire brigade panel)
- Monitored outputs for alarm transmission
- The SCP500 is an autonomous stand-alone control panel and cannot be networked

This type of control panel does not provide any options for fitting additional units.

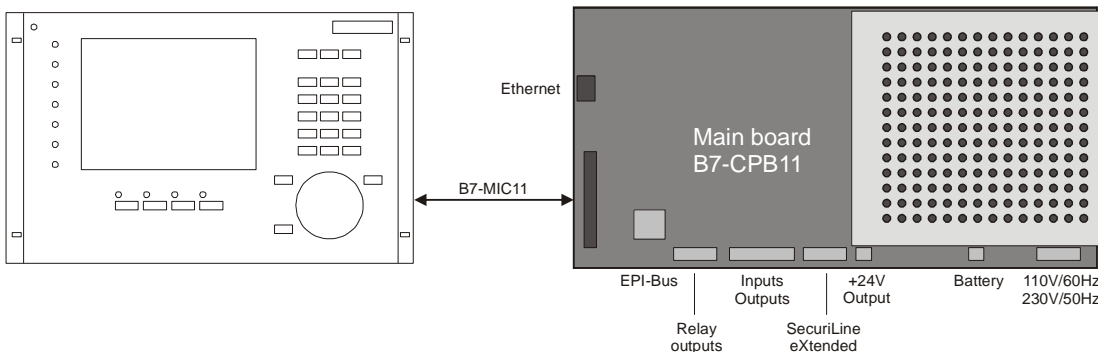

4 Indication and control maps



Main indication and control map
B5-MIC711
B6-MIC711

Dimensions: 276 x 170 x 52 mm

Language-neutral indication and control map for the fire alarm system as a whole. Can be networked with other control panels in SecuriLan.



Floor tablet
B5-MMI-FIP

Dimensions: 276 x 170 x 52 mm

Displays important operating states for a locally confined part of the system. Connected via MMI bus on SCP3000/2000/1000



LED partial indication map
B5-EPI-PIM

Dimensions: 138 x 170 x 52 mm

Alarm indicator for selected areas of the fire alarm system. Connection to MIC main indication and control map (internal or external) and mounting in its immediate vicinity.



Indication and control map
B5-EPI-PCM

Dimensions: 138 x 170 x 52 mm

Partial control map with indication and control of selected areas of the fire alarm system. Connection to MIC main indication and control map (internal or external) and mounting in its immediate vicinity.

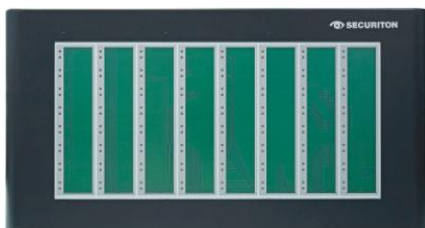

Partial indication map for detection zones
B3-MMI-EAT64-S

Dimensions: 228 x 445 x 48 mm

Device for indicating the status of individual detection zones using LEDs. The "Alarm", "Fault" and "Disablement" states of a detection zone can be indicated using two LEDs (red and yellow).

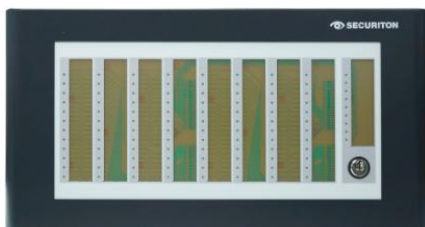

Partial indication map for extinguishing areas
B3-MMI-IPEL-S

Dimensions: 228 x 445 x 48 mm

Device for norm-compliant LED state display of connected extinguishing systems. Max. 8 extinguishing areas.

Indication and control maps



Fire brigade panel, Switzerland
B5-EPI-FPC-GS
Dimensions: 138 x 170 x 52 mm

Fire brigade panel complies with Swiss standard SN 054 002; in Switzerland it must be mounted in the immediate vicinity of every fire alarm system in the fire brigade access area. It displays specific operating states of the fire alarm systems and enables the fire service personnel to carry out essential operational procedures.



Fire brigade panel, Sweden
B5-EPI-FPS
Dimensions: 170 x 40 x 227 mm

External fire brigade panel.
Connected via EPI bus on
SCP3000/2000/1000/500.



Intervention panel, Sweden
B5-MMI-IPS
Dimensions: 170 x 40 x 227 mm

Intervention panel for starting and stopping inspection-times.
Text are free programmable.



Fire brigade panel, Germany
B5-EPI-FPD
Dimensions: 185 x 65 x 255 mm

External fire brigade panel.
Connected via EPI bus on
SCP3000/2000/1000/500.



Fire brigade panel, Germany
B5-MMI-FPD
Dimensions: 185 x 65 x 255 mm

External fire brigade panel.
Connected via MMI bus on SCP3000/2000/1000.



Fire brigade panel, Czechia
B5-EPI-FPCZ
Dimensions: 185 x 65 x 255 mm

External fire brigade panel.
Connected via EPI bus on
SCP3000/2000/1000/500.



Fire brigade panel, Czechia
B5-MMI-FPCZ
Dimensions: 185 x 65 x 255 mm

External fire brigade panel.
Connected via MMI bus on SCP3000/2000/1000.

5 SecuriLine eXtended

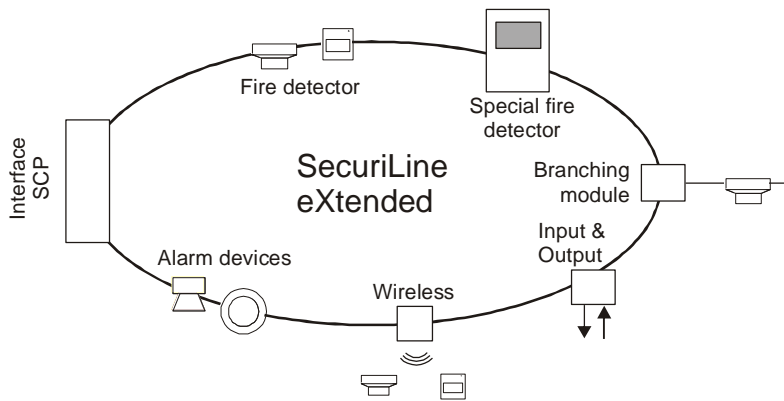

Main features of the SecuriLine eXtended addressable loop

- Up to 250 participants (see notice!)
- Up to 3500m loop length (see notice!)
- Each participant with integrated short-circuit isolator
- Individual address for each individual participant
- Integration of Securiton special fire alarm systems
- Interface for wireless fire detector
- Audible and optical alarm transmitters directly connectable





Notice

The actual loop length depends on the number and type (power consumption, inner resistance) of participants, on additional power load (number of switched on alarm LEDs, telegram current), and on the cable cross-section. This means that for the optimal configuration the number of participants and the coverage range of the loop must be matched to each other.

A tool is available for calculating the maximum possible loop length and the maximum number of participants.

5.1 Manual fire detectors

Directly connectable to SecuriLine eXtended; each element has its own individual address		
MCP545X-1N Manual Call Point Individually addressed	Application / feature <ul style="list-style-type: none"> • EN54-11 certified • Single action (break glass -> alarm) • With alarm indicator • For use in protected rooms, IP 24 • With transparent protective cover • Test key 	
MCP545X-4N Manual Call Point Individually addressed	Application / feature <ul style="list-style-type: none"> • EN54-11 certified • Single action (break glass -> alarm) • With alarm indicator • For use in unprotected rooms, IP 67 • With transparent protective cover • Test key 	
MCP535X Manual Call Point Individually addressed	Application / feature <ul style="list-style-type: none"> • Complies with VdS and EN54-11 • Double action (break glass, press button -> alarm) • With alarm indicator • For use in protected rooms, IP 52 / IP 54 • Available in a range of colours • For fire alarm systems as well as extinguishing systems 	

Collective detector Connectable via interfaces: BX-AIM or B3-IM8 or B6-EIO		
MCP521-1N Manual Call Point Collective	Application / feature <ul style="list-style-type: none"> • EN54-11 certified • Single action (break glass -> alarm) • For use in protected rooms, IP 24 • With transparent protective cover • Test key 	
MCP521-4N Manual Call Point Collective	Application / feature <ul style="list-style-type: none"> • EN54-11 certified • Single action (break glass -> alarm) • For use in unprotected rooms, IP 67 • With transparent protective cover • Test key • 	
MCP525 Manual Call Point Collective	Application / feature <ul style="list-style-type: none"> • Complies with VdS and EN54-11 • Double action (break glass, press button -> alarm) • With alarm indicator • For use in protected rooms, IP 52 / IP 54 • Available in a range of colours • For fire alarm systems as well as extinguishing systems 	

5.2 Automatic fire detectors

Securiton fire detectors are tested and approved in accordance with EN 54. Automatic fire detectors also feature a range of other important properties.

The detection properties of SecuriLine eXtended fire detectors are programmed using the fire alarm control panel. This greatly reduces the number of different products. If ambient conditions change, existing detectors are simply reprogrammed; no need for replacements.

The detectors have various pre-alarm levels, which are displayed and evaluated accordingly on the fire alarm control panel.

The sensors on combined detectors (smoke and/or temperature) can be switched on or off individually while the system is up and running. Example: Temperature only during daytime operation; temperature and smoke during night-time operation.

Smoke sensor technology:



All the detector variants have an integrated temperature sensor. This means they automatically adjust their smoke sensitivity to the environment and always within the tolerance permitted by the norm (CUBUS levelling®). This in turn avoids costly false alarm triggering and saves the time-consuming setting of parameters on site on detectors already installed. Any unacceptably high temperatures likely to damage the detector are also signalled.





Temperature sensor technology:

For each of the selectable heat classes A1, A2 and B, the parameters for the R and S indices can be set as required. Heat detectors with class index S are particularly well suited for applications with higher rates of temperature rise over longer periods of time, as for example in boiler rooms or kitchens. Heat detectors with class index R are particularly well suited for use in unheated buildings, where the ambient temperature may fluctuate considerably yet high rates of temperature rise are not sustained for long periods.

Gas sensor technology:

The CO cell detects the rise in carbon monoxide gas released during fires. It continuously measures the CO concentration in the room. Alongside the normative alarm this information can be displayed on the fire alarm control panel as a technical CO alarm in accordance with EN 50291-1. The adjustable technical CO pre-alarm (20-320ppm) can also be used to issue an early warning to protect people from the potential risk of asphyxiation.

Directly connectable to SecuriLine eXtended; each element has its own individual address		
<p>MCD573X Multi Criteria Detector</p>	<p>Application / feature</p> <ul style="list-style-type: none"> • One detector for smoke detection (EN54-7) and heat detection (EN54-5) from a fire. • The evaluation of fire characteristics such as smoke and temperature can be controlled as a function of time (day/night). • Automatic sensitivity adjustment of the smoke detection according to the ambient temperature (Cubus levelling) • Also: heat indices R and S for special applications such as kitchens and unheated premises • Integrated data memory for logging key data in the event of an alarm • Patented method for checking the smoke and heat element quickly and simply using test gas • Available in own choice of RAL colour to order • Dimensions Ø x H: 118.8x 58.1 mm 	
<p>MCD573X-S MCD573X-SCT</p>	<p>Is identically to MCD573X, additionally</p> <ul style="list-style-type: none"> • with an integrated audible signal transmitter.. • Sound pressure setting 69dB(A), 81 dB(A) or 92dB(A). • 4 settable sounds: DIN-sound (1200 ~ 500Hz), Slow Whoop (500 ~ 1200Hz), continuous/intermittent (990Hz), Sweden sound (660 Hz 150ms pulse). • Certified acc. EN54-3 • MLAR-variant (-SCT) for uninterrupted alarm transmission 	
<p>MCD573X-SP MCD573X-SPCT</p>	<p>Is identically to MCD573X-S, additionally</p> <ul style="list-style-type: none"> • Language output in 4 languages, each with 3 texts • MLAR-variant (-SPCT) for uninterrupted alarm transmission 	
<p>CCD573X</p>	<p>Application / feature</p> <ul style="list-style-type: none"> • Smoke detection (EN54-7), heat detection (EN54-5), gas detection (EN 54-26), detection algorithm from heat and smoke detection (EN54-29) and detection algorithm from heat and CO detection (EN54-30), all in one detector. • The evaluation of fire characteristics such as smoke, temperature and CO can be controlled as a function of time (day/night). • Automatic sensitivity adjustment of the smoke detection according to ambient conditions CO & temperature (2x Cubus levelling) • Also: heat indices R and S for special applications such as kitchens and unheated premises • Integrated data memory for logging key data in the event of an alarm • Available in own choice of RAL colour to order • Dimensions Ø x H: 118.8x 58.1 mm 	

Collective detector Connectable via interfaces: BX-AIM or B3-IM8 or B6-EIO		
SCD563 Smoke Criteria Detector Collective	Application / feature <ul style="list-style-type: none"> • Heat detection (EN54-5). • Automatic sensitivity adjustment according to ambient conditions (Cubus levelling) • Patented method for checking the smoke element quickly and simply using test gas • Available in own choice of RAL colour to order • Dimensions Ø x H: 118.8x 58.1 mm 	
TCD563 Temperature Criteria Detector Collective	Application / feature <ul style="list-style-type: none"> • Fire smoke detection (EN54-7). • Detector variants for heat class A1, A2 and B • Patented method for checking the heat element quickly and simply using test gas • Available in own choice of RAL colour to order • Dimensions Ø x H: 118.8x 58.1 mm 	
Modernisation detector. Connectable via B3-LEE23 interface. Each element has its own individual address		
MMD140 Smoke or heat detector	Application / feature <ul style="list-style-type: none"> • For smoke detection (EN54-7) or heat detection (EN54-5) for classes A1, B. • Automatic sensitivity adjustment according to ambient conditions (Cubus levelling) • Detector address (1...30) is set on the detector • Separate detector base USB502 • Dimensions Ø x H: 118.8x 58.1 mm 	
Modernisation detector. Connectable via B3-LEE24 interface. Each element has its own individual address		
MMD150 Smoke or heat detector	Application / feature <ul style="list-style-type: none"> • For smoke detection (EN54-7) or heat detection (EN54-5) for classes A1, B. • Automatic sensitivity adjustment according to ambient conditions (Cubus levelling) • Detector address (1...127) is set on the detector • Separate detector base USB502 • Dimensions Ø x H: 118.8x 58.1 mm 	





5.3 Base for automatic fire detectors





USB502-1 Detector base	Application / feature <ul style="list-style-type: none"> • Detector base for fire detector series 573, 563 and MMD140/150 • Quick-fit detector using bayonet lock • Integrated loop contact prevents interruption when detector is removed 	
USB502-2	<ul style="list-style-type: none"> • Variant for flush-mounting 	
USB502-3	<ul style="list-style-type: none"> • Variant for wet rooms 	
USB502-4	<ul style="list-style-type: none"> • Variant for mounting on concrete 	
USB502-5	<ul style="list-style-type: none"> • Variant for raised floors 	
USB502-6	<ul style="list-style-type: none"> • Variant without loop contact 	
USB502-20	<ul style="list-style-type: none"> • Variant with illuminated ring, 	
USB502-7 Ex-i USB502-8 Ex-i	<ul style="list-style-type: none"> • Variants for areas subject to explosion hazards with MMD130 Ex-i 	

5.4 Room indication lamps



Suitable for operating on SecuriLine eXtended		
RAL720X Room indication lamp	Application / feature <ul style="list-style-type: none"> • Alarm indicator lamp for connection to SecuriStar detectors or suitable open collector output board • For use in protected rooms • Surfacing mounting • Compatible with SecuriLine eXtended • Dimensions: 85 x 85 x 30 mm 	
Suitable for operating on SecuriLine		
RAL721 Room indication lamp	Application / feature <ul style="list-style-type: none"> • Alarm indicator lamp for connection to SecuriStar detectors or suitable open collector output board • For use in wet environments • Surfacing mounting • Not compatible with SecuriLine eXtended • Dimensions: 53 x 53 x 70 mm 	
RAL722 Room indication lamp	Application / feature <ul style="list-style-type: none"> • Alarm indicator lamp for connection to SecuriStar detectors or suitable open collector output board • For direct installation in ceiling panels or door frames • Available with additional cover plate (not shown). • Not compatible with SecuriLine eXtended • Dimensions Ø x H: 20 x 68 mm 	

5.5 Sirens and flashlights

Directly connectable to SecuriLine eXtended; each element has its own individual address		
BX-SOL BX-SOL-CT Loop siren	Application / feature <ul style="list-style-type: none"> Adjustable sound pressure 89dBA or 99dBA. Choice of 4 different types of tone: DIN tone (1200 ~ 500Hz), Slow Whoop (500 ~ 1200Hz), continuous/pulsating tone (990Hz), Sweden tone (660 Hz 150ms pulse). Certified in accordance with EN54-3 For use in protected rooms, IP 21C MLAR-variant (-SCT) for uninterrupted alarm transmission Available in the colours red and white Dimensions Ø x H: 108 x 98 mm 	
BX-SBL502 Loop siren	Application / feature <ul style="list-style-type: none"> Adjustable sound pressure 80dBA or 90dBA. Choice of 4 different types of tone: DIN tone (1200 ~ 500Hz), Slow Whoop (500 ~ 1200Hz), continuous/pulsating tone (990Hz), Sweden tone (660 Hz 150ms pulse). Certified in accordance with EN54-3 For use in protected rooms, IP 31c Available in the colours red and white Dimensions Ø x H: 114 x 32 mm 	
BX-SBL501 Loop siren with de- tector base	Application / feature <ul style="list-style-type: none"> Adjustable sound pressure 80dBA or 90dBA. Choice of 4 different types of tone: DIN tone (1200 ~ 500Hz), Slow Whoop (500 ~ 1200Hz), continuous/pulsating tone (990Hz), Sweden tone (660 Hz 150ms pulse). Certified in accordance with EN54-3 For use in protected rooms, IP 31c Dimensions Ø x H: 117 x 41 mm 	 <p><i>The detector must be ordered separately.</i></p>
BX-FOL Loop flashlight	Application / feature <ul style="list-style-type: none"> Adjustable flash frequency 0.5Hz (slow) or 1Hz (fast). Certified in accordance with EN54-3 For use in protected rooms, IP 21c Map case available in the colours red and white Lenses available in the colours red and orange Dimensions Ø x H: 93 x 54 mm 	

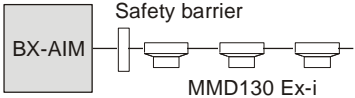
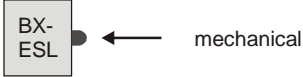
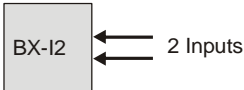
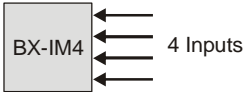
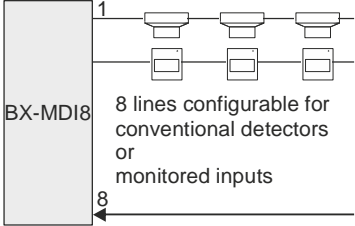
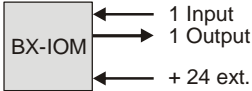

Alarm media connectable via outputs		
BSE128 Siren	Application / feature <ul style="list-style-type: none"> • Sound pressure up to 115dBA (98dBA for DIN tone) • Choice of 28 different types of tone. • Certified in accordance with EN54-3 • Available in protection classes IP54 and IP65 • Available in the colours red and white • Variant available for flush mounting (white only) • Dimensions Ø x H: 101 x 81 mm 	
Solex Flashlight	Application / feature <ul style="list-style-type: none"> • Flashing frequency 1Hz • Protection class IP54 • Lenses available in a range of colours • Dimensions Ø x H: 93 x 63 mm 	
Sonos -B Flashlight	Application / feature <ul style="list-style-type: none"> • Adjustable flash frequency 0.5Hz (slow) or 1Hz (fast). • Protection class IP21C / IP65 • Certified in accordance with EN54-23 • Available in the colours red and white • Dimensions Ø x H: 100 x 94/100/117/122 mm • 	
Sonos -SB Siren/Flashlight	Application / feature <ul style="list-style-type: none"> • Sound pressure up to 97dBA (DIN tone) • Choice of 32 different types of tone. • Adjustable flash frequency 0.5Hz (slow) or 1Hz (fast). • Protection class IP21C / IP65 • Certified in accordance with EN54-3 and EN54-23 • Available in the colours red and white • Dimensions Ø x H: 100 x 94/100/117/122 mm 	

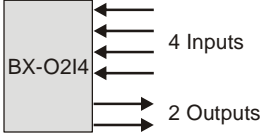
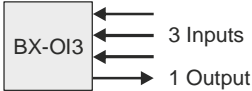
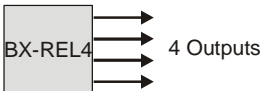
5.6 SecuriLine eXtended line modules

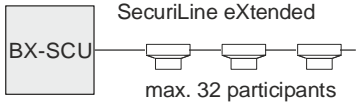
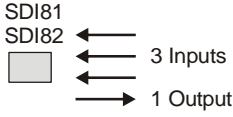
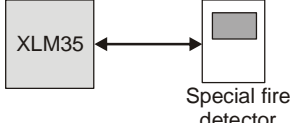

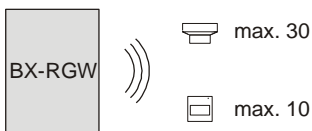

BX-AIM Branching module	Application / feature <ul style="list-style-type: none"> • 1 monitored input • Connection of conventional detectors 	
BX-ESL End switch module	Application / feature <ul style="list-style-type: none"> • For monitoring the tappet position • For monitoring sprinkler systems • For monitoring blocking equipment (extinguishing systems) 	
BX-I2 Input module	Application / feature <ul style="list-style-type: none"> • 1 input individually adjustable as monitored/not monitored • 1 opto-isolator input for monitoring external voltages • Polling of potential-free contacts 	
BX-IM4 Input module	Application / feature <ul style="list-style-type: none"> • 4 inputs • Inputs individually adjustable as monitored/not monitored • Polling of potential-free contacts 	
BX-MDI8 Input module	Application / feature <ul style="list-style-type: none"> • 8 monitored inputs • Connection of conventional detectors 	
BX-IOM Input and output module	Application / feature <ul style="list-style-type: none"> • 1 input • 1 monitored output • Actuation of monitored consumer units • Polling of potential-free contacts 	
BX-O1 Output module	Application / feature <ul style="list-style-type: none"> • 1 non-monitored relay output, changeover contact • Contact load 230V / 2A • Switches loads of up to 2 A and up to 230 V 	
BX-O2I4 Output and input module	Application / feature <ul style="list-style-type: none"> • 2 non-monitored relay outputs, changeover contacts • 4 inputs, individually adjustable as monitored/not monitored • Polling of potential-free contacts • Contact load 230V / 2A • Switches loads of up to 2 A and up to 230 V 	
BX-OI3 Output/input module	Application / feature <ul style="list-style-type: none"> • 1 output and 3 inputs • Polling of potential-free contacts • Connection of Securitron special fire alarm systems: ARDEA, ASD51x, ADW511, UNILASER XL, ECO, BSD535 	
BX-REL4 Output module	Application / feature <ul style="list-style-type: none"> • 4 non-monitored relay outputs, changeover contacts • Contact load 230V / 2A • Switches loads of up to 2 A and up to 230 V 	

<p>BX-SCU Branching module</p>	<p>Application / feature</p> <ul style="list-style-type: none"> • 1 stub line SecuriLine eXtended • Connection of max. participants 	 <p>SecuriLine eXtended BX-SCU — max. 32 participants</p>
<p>SDI81X SDI82X Input module</p>	<p>Application / feature</p> <ul style="list-style-type: none"> • 3 inputs • 1 output, not potential-free, for alarm indicators max. 5mA • Connection of detectors with alarm contacts • Polling of potential-free contacts 	 <p>SDI81 SDI82 3 Inputs 1 Output</p>
<p>XLM35/SLM35 Interface module</p>	<p>Application / feature</p> <ul style="list-style-type: none"> • Interface for connecting Securiton special fire alarm systems: SecuriSens, ASD535 	 <p>XLM35 Special fire detector</p>

5.7 Wireless

<p>BX-RGW Radio Gateway Module</p>	<p>Application / feature</p> <ul style="list-style-type: none"> • Interface for up to 30 wireless smoke detectors or 10 wireless manual call points 	 <p>BX-RGW max. 30 max. 10</p>
<p>SMF 6120 Wireless manual call points</p>	<p>Application / feature</p> <ul style="list-style-type: none"> • Range of up to 40m with visual contact 	
<p>DOW 1171 Wireless smoke de- tector</p>	<p>Application / feature</p> <ul style="list-style-type: none"> • Range of up to 40m with visual contact 	

5.8 Ex-zone detector

Connectable via Z787 safety barrier on interface for BX-AIM or B3-IM8 collective alarm lines		
MMD 130 Ex-i Detector for smoke and heat Collective Explosion-proof	Application / feature <ul style="list-style-type: none"> • Detection response (smoke in accordance with EN54-7 or heat in accordance with EN54-5) adjustable on the detector. • For Ex-zones 1 and 2 • Max. 10 detectors per line • Separate detector base USB502-7/8 Ex-i Dimensions Ø x H: 118.8x 58.1 mm	
MCP521 N Ex-i Manual Call Point Collective Explosion-proof	Application / feature <ul style="list-style-type: none"> • EN54-11 certified • Single action (break glass -> alarm) • For use in rooms subject to explosion hazards, IP 24 • With transparent protective cover • Test key Dimensions: 89 x 93 x 61.5 mm	
MCP521-4 N Ex-i Manual Call Point Collective Explosion-proof	Application / feature <ul style="list-style-type: none"> • EN54-11 certified • Single action (break glass -> alarm) • For use in rooms subject to explosion hazards, IP 67 • With transparent protective cover • Test key Dimensions: 97.5 x 93 x 73 mm	
Z787 Safety barrier for MMD130 Ex-i and MCP521 N Ex-i	Application / feature <ul style="list-style-type: none"> • 1 x Z787 per detector line • Maximum of 10 MMD130 Ex-i connectable • Connectable to SecuriLine eXtended via BX-AIM loop module or to SCP3000 via B3-IM8 line interface. 	

5.9 Door holding magnet

Directly connectable to SecuriLine eXtended; each element has its own individual address		
BX-MDH Door holding magnet	Application / feature <ul style="list-style-type: none"> • Can be connected to the SecuriLine eXtended • The module keeps fire protection doors open in the normal state and closes them in the event of an alarm. • Requires an internal battery but no external power supply • Integrated monitoring of the door position 	

5.10 Special fire detectors

Securiton offers its own proprietary systems for fire detection in special environments:

ASD535	aspirating smoke detection system
ASD532	aspirating smoke detection system
ASD531	aspirating smoke detection system
ADW511A	linear heat detector
ADW535	linear heat detector
d-List	linear heat detector
LIST	linear heat detector

Get in touch with your Securiton contact for detailed information about these products or find out more from the Securiton web page: <http://www.securiton.com>

6 Article Numbers

The article numbers for all the products mentioned in this document and other SecuriFire products can be found in the current SecuriFire product catalogue.

7 System planning

The information below complies with the requirements set out in EN54.

A fault in the control panel must not affect a monitoring area greater than 12000m² or more than 512 detectors. This applies to the non-redundant control panel types SecuriFire 500, SecuriFire 1000 and SecuriFire 2000.

If a control panel has a monitoring area greater than 12000m² or with more than 512 detectors, the detection zones must continue to function despite the control panel fault. With its consistent redundancy design the SecuriFire 3000 control panel complies with this requirement and is not subject to any restrictions with regard to the monitoring area and/or the number of detectors.

The fire alarm state must automatically be displayed both audibly and optically.

In the event of a fire alarm the alarm sirens and alarm indicators as well as an alarm transmission device must be activated. The status of these devices must also be displayed.



SecuriFire 500



SecuriFire 1000 / SF2000



SecuriFire 3000

7.1 Detection area

A detection area must cover no more than one floor of a building. Exceptions include stairwells, light shafts, elevator shafts or tower-like structures, each of which can form a separate detection area.

A detection area must not exceed one fire sector and must not be larger than 1600m².

Several rooms may only be grouped together to form one common detection area if

- they consist of a maximum of 5 adjacent rooms with a maximum total surface area of 400m², or
- they consist of adjacent rooms with easily surveyable doors with a maximum total surface area of 1000m². Also with clearly visible optical alarm indicators near to or above the door for the alarm identification of the room in question. The displays must be labelled accordingly (e.g. according to DIN 14623).

Alternatively the alarms of the rooms in question can be displayed on the fire alarm control panel.

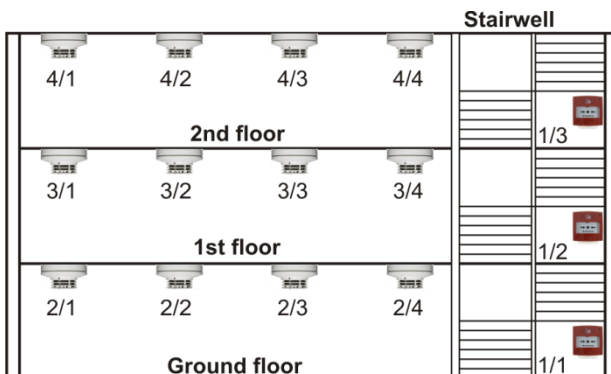
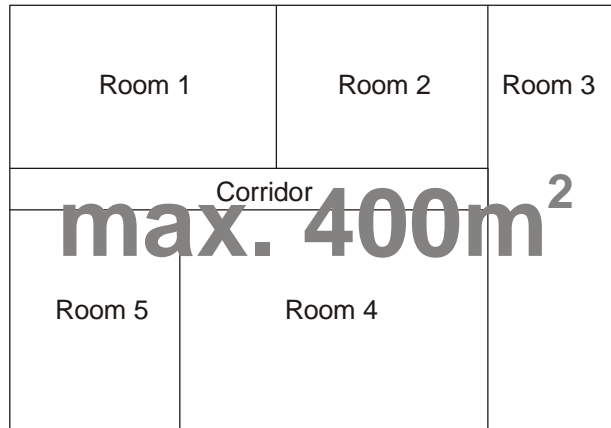

7.2 Detection zone

A detection zone may only comprise detectors within one detection area.

Separate detection zones are to be provided for automatic and manual fire detectors.

A maximum of 32 physical detectors are permitted per detection zone.

Separate detection zones are to be provided for automatic detectors in raised floors, dropped ceilings or cable shafts. In other respects the detection zone which has detectors in an alarm state must be very clear to spot.

This can be achieved for example using external alarm indicator lamps.

Detectors in ventilation shafts must have a separate detection zone.

Manual fire detectors in stairwells with more than 2 floors must be programmed in a separate detection zone; they must not be included in the detection zones of each individual floor.

Provision must be made for switching off the detection zones independently of one another.

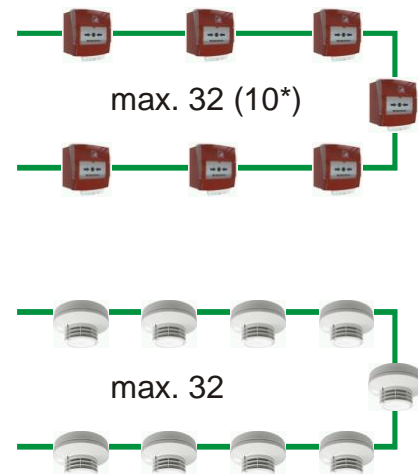

** Restriction in accordance with VdS 2095*

7.3 Avoidance of false alarms

Fire alarm systems may feature an appropriate technical facility for verifying alarms, such as

- a 2-detector dependency
- a 2-detection zone dependency

With a two-detector or two-detection zone dependency the dependent detectors must be at least 2.5m apart.

Dependency on more than 2 detectors or 2 zones to achieve the fire alarm state is not permitted.

In a 2-detection zone dependency, multiple-criteria detectors (e.g. smoke and heat) are considered as 1 detector only as there is no local separation.

The detectors are to be spread out evenly and symmetrically as a matter of principle. Permissible deviations from the ideal layout are based on the permissible spacings between detectors for smoke & heat detectors. The pitch of the ceiling and the max. monitoring area are to be taken into account.

Fire alarm systems may feature an appropriate manual facility for verifying alarms.

The fire alarm can be transmitted to the alarm receiving centre after a delay. This is subject to the following conditions:

- The delay is permissible only if there are people present.
- The alarm must be acknowledged within 30 s.
- During that time the alarm will not be transmitted.
- The maximum inspect time after the acknowledgement is 3min.
- If another alarm is received during that time, alarm transmission is immediate.

Planning a detector or zone dependency does not affect the maximum number of detectors per detection area.

Local fire service regulations may stipulate a detector or zone dependency for automatic alarm transmission.

The functions described do not apply to manual fire detectors.

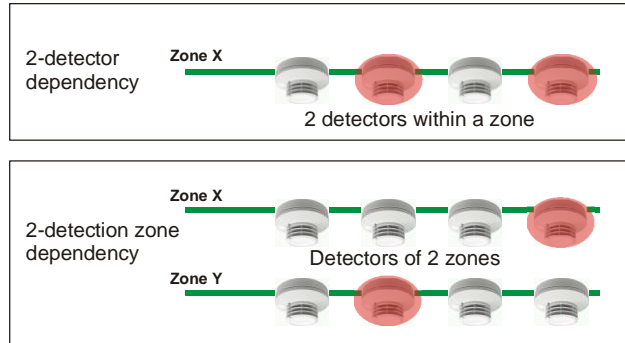

7.4 Positioning of automatic fire detectors

Automatic fire detectors must be installed in such a way that the fire characteristics (smoke, heat, gas) are able to reach them unimpeded.

The number and placement depend on:

- the room height
- the surface area
- the shape of the ceiling and roof
- the maximum monitoring area per detector

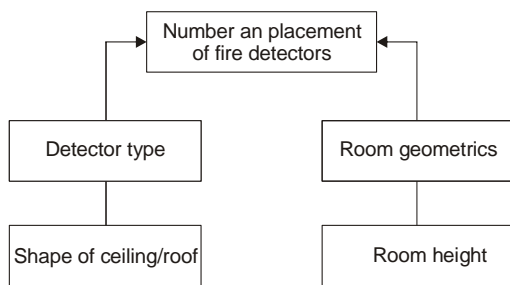

At least one automatic fire detector must be installed in each room of the monitored area, except for rooms with a low fire hazard and no possibility of the fire spreading.

Any areas where people's lives might be at risk in the event of a fire, i.e. sub-areas where smoke might spread, are also to be considered as rooms.

Ceilings that are perforated for purposes of forced ventilation must be sealed within a 0.5m radius of the detector. The number of point detectors for smoke or heat must be selected in such a way that the maximum monitoring area per detector is not exceeded.

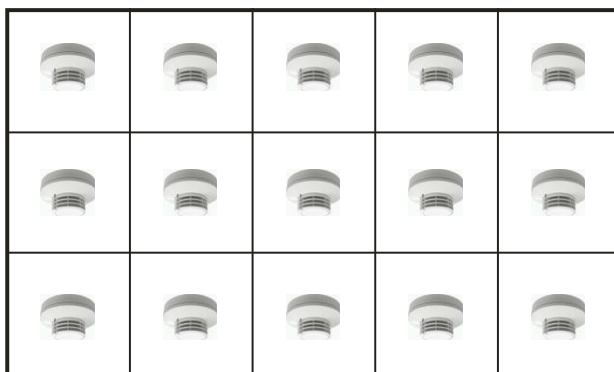

Dependency on more than 2 detectors or 2 zones to achieve the fire alarm state is not permitted.

In a 2-detection zone dependency, multiple-criteria detectors (e.g. smoke and heat) are considered as 1 detector only as there is no local separation.

The detectors are to be spread out evenly and symmetrically as a matter of principle. Permissible deviations from the ideal layout are based on the permissible spacings between detectors for smoke & heat detectors. The pitch of the ceiling and the max. monitoring area are to be taken into account.

In special cases other or additional measures may be necessary to prevent false alarms.

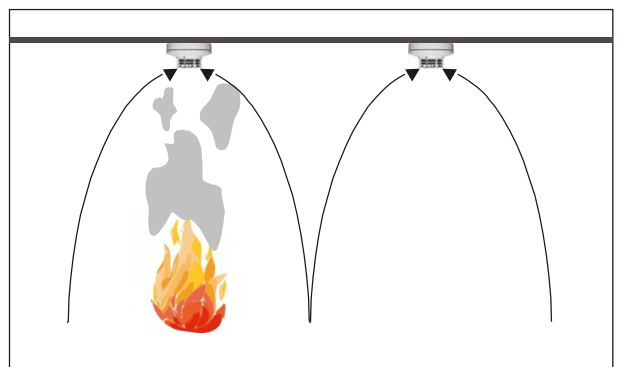

7.5 Choice of fire detector types based on ambient conditions

Ambient conditions	Smoke detection	Heat detection
Ambient temperature:	Smoke detection -25°C to +60°C Potential ice formation is to be prevented at temperatures < 0°C	Heat detection -5°C to +60°C Depending on temperature and application Class A1, A2 or B with Class Index S or R
Application temperature:		acc. EN54-5 ,A1 and A2: typ. 25°C, max. 50°C acc. EN54-5, B: typ. 40°C, max. 65°C
Static response temperature:		acc. EN54-5 ,A1: min. 54°C, max. 65°C acc. EN54-5 ,A2: min. 54°C, max. 70°C acc. EN54-5 ,B: min. 69°C, max. 85°C
Air velocity	Smoke detection Max. 20m/s	Heat detection No restriction
Vibration	The detectors are not suitable for environments subject to vibrations. The appropriate counter-measures must be adopted.	
Humidity	10...95% rel. humidity. Non-condensing	
Smoke, dust and other aerosols	Smoke detection Cause of false alarms Mount the detector in a more suitable position or use a heat detector	Heat detection No restriction
Exposure to light sources	No negative impact	

7.6 Room heights

Each detection method is approved only up to a specific room height.

Ceiling areas which make up less than 10% of the overall ceiling area are not taken into account except if this area makes up more than 60% of the detector's maximum monitoring area.

In such cases the higher areas of the ceiling must be considered as separate rooms.

Securiton special fire systems are used for room heights that are unsuitable for point detectors:

Room height	Smoke detector in accordance with EN54-7	Heat detector in accordance with EN54-5	
		Class A1	Class A2, B
> 12m	unsuitable	unsuitable	unsuitable
< 12m	suitable	unsuitable	unsuitable
< 7.5m	suitable	suitable	unsuitable
< 6m	suitable	suitable	suitable

7.7 Monitoring areas for point detectors

Basic surface area of the monitored room	Detector type	Room height	Max. monitoring area	
			Roof/ceiling pitch <20°	Roof/ceiling pitch >20°
>80m ²	Smoke detector in accordance with EN54-7	6-12m	80m ²	110m ²
<80m ²		<6m	60m ²	90m ²
>30m ²	Heat detector. EN54-5 Cl. A1 Heat detector. EN54-5 Cl. A2, B	< 7.5m	20m ²	30m ²
<30m ²		< 6m	30m ²	40m ²

7.8 Distance between detector and ceiling or roof

Smoke detector

The required distance between smoke detectors and the ceiling/roof depends on the room height, the pitch of the roof and the heat buffer anticipated based on the design of the roof. See table for standard distances

Heat detector

Heat detectors are always mounted directly to the ceiling.

Room height	Distance between detector and ceiling	
	Roof/ceiling pitch	
	<20°	>20°
>6m	<0.4m	0.35m to 1.0m
<6m	<0.25m	0.2m to 0.5m

Detector distance for different shapes of ceiling or roof

In the case of rooms with roofs with a pitch greater than 20°, e.g. slanting roof, gabled roof or hipped roof, a row of detectors must be installed vertically under the roof ridge or the highest point of the room, with pendant length DL.

In rooms with shed roofs each shed must have its own row of detectors, as illustrated in the figure. The detectors are mounted to the ceiling area with the smallest pitch at a distance DV from the ridge and with a pendant length DL.

If further rows of detectors are required, the distance DL from the roof applies to all roof shapes up to a pitch of 20°.

With vaulted ceilings the following simplified assumption is used to calculate the pitch:

Average roof pitch less than 20° if: $\frac{GH}{GB} \leq 0.182$.

Average roof pitch greater than 20° if: $\frac{GH}{GB} \leq 0.182$.

Vault height $GH = RH - VH$

Vault width GB

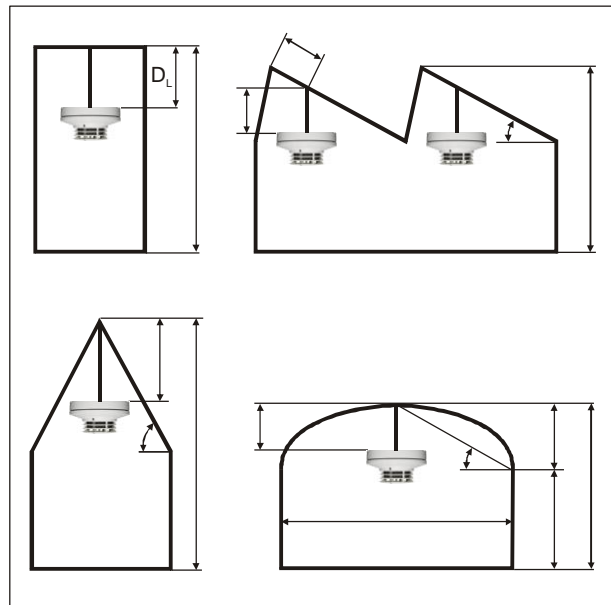

7.9 In narrow corridors and ceiling areas

- The distance between heat detectors can be up to 10m or 5m in the case of 2-detector or 2-zone dependency
- The distance between smoke detectors can be up to 15m or 11m in the case of 2-detector or 2-zone dependency or 7.5m if extinguishing systems are actuated.
- The distance between the detector and the end of the corridor or ceiling area must not exceed half the specified distances.
- The maximum areas monitored by the detectors must not be exceeded.

7.10 Distances from walls

- The distance to the wall must not be less than 0.5m.
- The only exceptions are corridors and similar areas less than 1m wide.
- If the room is subdivided into areas less than 0.15 m from the ceiling the distance of 0.5 m applies also to the subdivided areas.

7.11 Distance from stored goods and storage facilities

- The distance between the detector and the stored goods and/or storage facilities must not exceed 0.5m at any point.

7.12 Positioning of manual fire detectors MCP

Manual fire detectors must be:

- mounted in a clearly visible location
- easily accessible
- mounted at a height of $1.4\text{m} \pm 0.2\text{m}$ above ground
- sufficiently illuminated by daylight or other light source. Any emergency lighting installed must illuminate the MCP.
- mounted in evacuation corridors or escape routes

Any MCP that is out of commission must be labelled accordingly (e.g. out of service)

* In locations with a low fire risk the distance between two MCPs must not exceed 100m

In critical environments or depending on the structural properties of the premises the distance between MCPs should not exceed 40 m

The layout and number of detectors must be such that a person does not have to walk more than 30m to reach the nearest MCP.

